



DOC#:01.13.005100

YDLIDAR TIA DATA SHEET ^{BETA}



www.ydlidar.com

Shenzhen EAI Technology Co.,Ltd.

CONTENTS

1	PRODUCT OVERVIEW	1
1.1	Product Features	1
1.2	Applications.....	1
1.3	Installation and Dimensions.....	1
2	SPECIFICATIONS	2
2.1	Performance Parameter	2
2.2	Physical Parameters.....	3
2.3	Default Settings.....	3
2.4	Interface Definition.....	3
2.5	Optical Characteristic.....	4
2.6	Polar Coordinate System Definition	4
3	DEVELOPMENT AND SUPPORT	5
4	REVISION	6

1 PRODUCT OVERVIEW

YDLIDAR TIA is a series of 2D LiDAR (hereinafter referred to as TIA) developed by EAI team. Based on ToF principle, TIA is based on the single-line scanning design and can output 20K (up to 40K) point cloud data per second. It adopts 905nm infrared excitation light, with the self-developed signal processing algorithm, to meet the requirement of outdoor application scenarios. TIA also adopts industrial interface design to transmit point cloud data through network protocol, and the dustproof and waterproof of the whole device reaches IP67 level. TIA structure design is compact, easy to integrate, and provides a complete integrated development interface, widely used in robot navigation and obstacle avoidance, environmental scanning and mapping, industrial AGV, assisted driving and other fields.

1.1 Product Features

- High speed range and frequency range of 20 KHz (up to 40KHz)
- Ranging repeat of high precision, good consistency
- 300 degrees horizontal view
- Maximum 30 Hz scanning frequency can be configured
- Strong resistance to ambient light interference
- IP67 protection level of dustproof and waterproof
- 100M adaptive network interface for data transmission

1.2 Applications

- Robot navigation and obstacle avoidance
- Industrial automation
- Regional security
- Smart transportation
- Environmental scanning and 3D reconstruction
- Digital multimedia interaction
- Robot ROS teaching and research

1.3 Installation and Dimensions

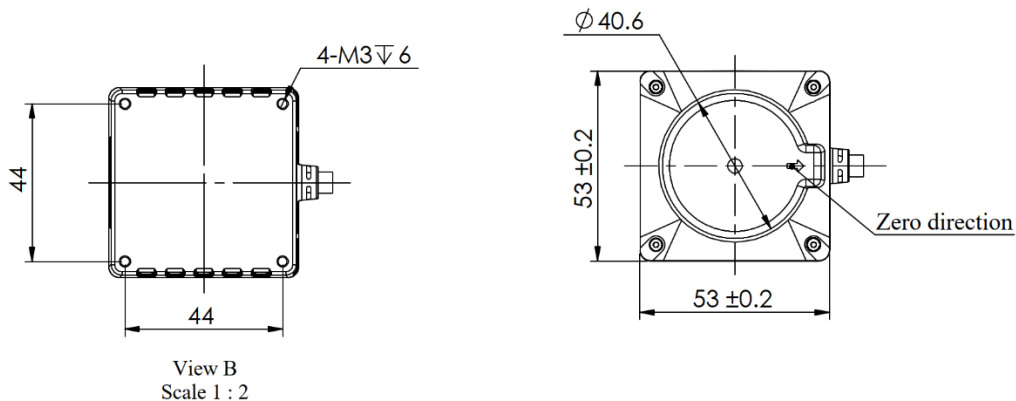

FIG 1 YDLIDAR TIA INSTALLATION DIMENSION (UNIT:MM)

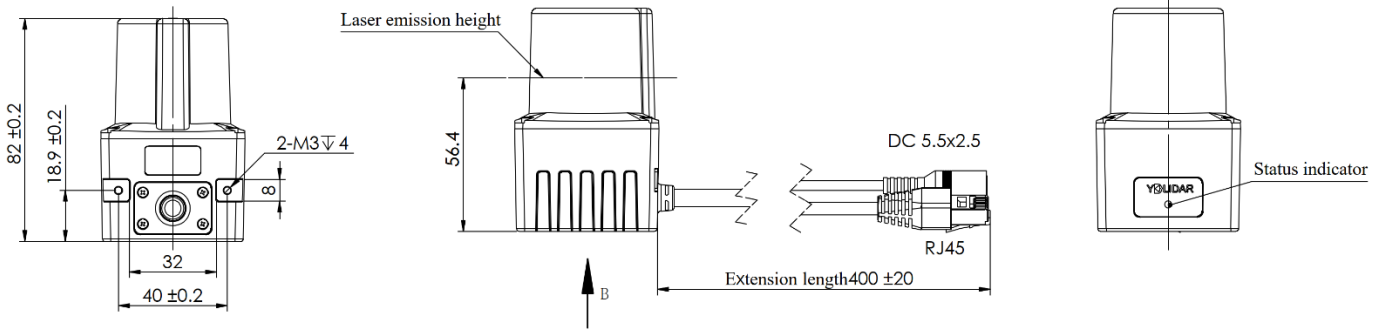

FIG 2 YDLIDAR TIA MECHANICAL DIMENSION (UNIT:MM)

2 SPECIFICATIONS

2.1 Performance Parameter

CHART 1 YDLIDAR TIA PERFORMANCE PARAMETER

Item	Min	Typical	Max	Unit	Remarks
Ranging frequency	10000	20000	40000	Hz	Customizable 40KHz
Scanning frequency	10	20	30	Hz	Software control
Ranging distance	0.05	/	25	m	80% reflectivity
	0.05	/	10	m	10% reflectivity
Field of view	/	300	/	Deg	/
Statistical error	/	20	/	mm	/
Angle resolution	0.18 (10Hz)	0.36 (20Hz)	0.54 (30Hz)	Deg	Ranging frequency=20KHz
	0.09 (10Hz)	0.18 (20Hz)	0.27 (30Hz)	Deg	Ranging frequency=40KHz

Note 1: It is factory FQC standard value, 80% reflectivity material object.

Note 2: Lidar is a precision device, please avoid using Lidar under high or low temperature or strong vibration situation, the systematic error parameter index will be relatively larger, and it may exceed the typical value.

2.2 Physical Parameters

CHART 2 YDLIDAR TIA PHYSICAL PARAMETERS

Item	Min	Typical	Max	Unit
Supply voltage	9	12	28	V
Operating power	2.4	2.7	3	W
Operating temperature	-20	25	50	°C
Laser wavelength	895	905	915	nm
Lighting environment	/	80000	/	lux
Degree of protection	/	IP67	/	/
Weight	/	230	/	g
Dimension	/	53*53*82	/	mm

2.3 Default Settings

CHART 3 YDLIDAR TIA DEFAULT SETTINGS

Item	Default value	Remarks
Network IP	192.168.0.11	configurable
Ranging zero	Center point of lidar	unconfigurable
Direction of rotation	Clockwise (top view)	unconfigurable
Angle zero	Arrow direction on top of protective cover	configurable
Indicator light	Steady red: The system is in standby state Steady green: The system is working	unconfigurable

2.4 Interface Definition

TIA has its own connection cables, and the cable is separated into the network port and the power port by splitting in two. The RJ45 network interface is used for data transmission and supports 10M/100M adaptive network. The DC5.5*2.5 interface for power supply, support wide voltage input (9-28V).

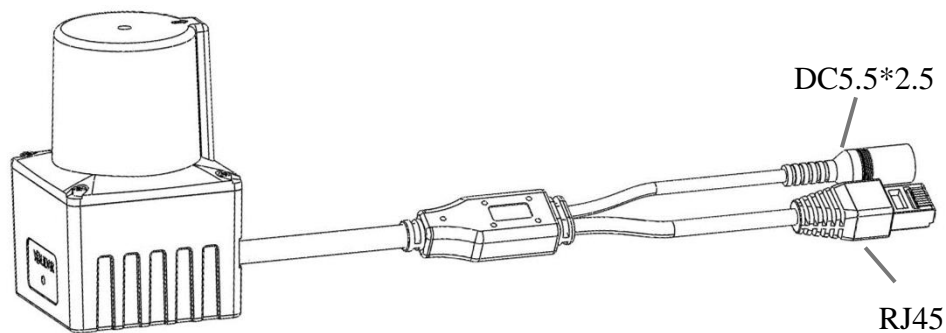

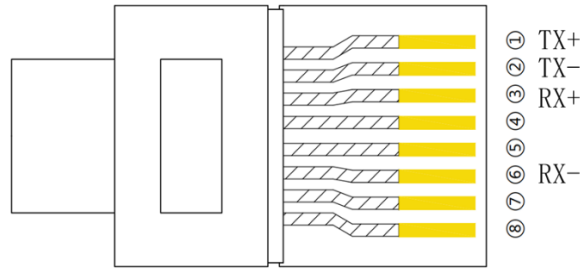
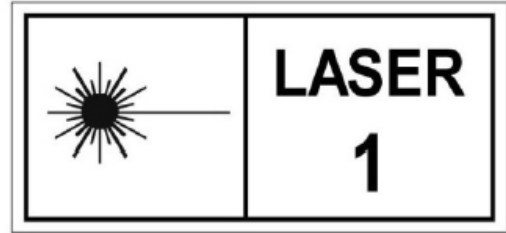

FIG 3 YDLIDAR TIA INTERFACES

2.5 Optical Characteristic

The infrared point pulse laser used in TIA can ensure the safety of human and pet. The lidar has passed testing and conformed to Class I, 21 CFR 1040.10 and 1040.11 safety level, except for IEC 60825-1 Ed. 3., as described in Laser Notice No. 56, dated May 8, 2019.



The laser and optical lens finish the transmission and reception of the laser signal to achieve high-frequency ranging while working. The detailed optical parameters are as follows:

CHART 4 YDLIDAR TIA LASER OPTICAL PARAMETERS

Item	Min	Typical	Max	Unit	Remarks
Laser wavelength	895	905	915	nm	Infrared band
FDA	 Class I IEC60825-1				

Note: The personal adjustment or reassembly of the Lidar may result in hazardous radiation exposure.

2.6 Polar Coordinate System Definition

In order to facilitate secondary development, TIA internally defines a polar coordinate system. The polar coordinates of the system take the center of the rotating core of TIA as the pole, and the specified Angle is positive clockwise (top view). The zero Angle is located in the direction of the arrow at the top of the protective cover, as shown in the figure:

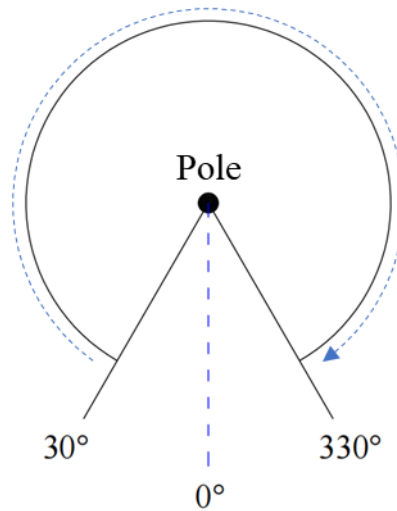

FIG 4 YDLIDAR TG5 POLAR COORDINATE SYSTEM DEFINITION

3 DEVELOPMENT AND SUPPORT

TIA provides a wealth of software interfaces, which can realize the motor enabling control, speed control, range unit enabling control and output control of the system. On this basis, users can also implement the power control and scan control purpose.

Also, the 3D model of TIA is disclosed. YDLIDAR provides the graphics debugging Workstation under Windows, as well as the corresponding SDK and ROS development kit to users, which could be downloaded from our website: <https://www.ydlidar.com/>.

In order to facilitate users' development, TIA development manual, SDK development manual and ROS user manual are also provided. Please download them from [our website](#).

4 REVISION

Date	Version	Content
2022-11-01	0.1.0	The 1st release
2023-01-10	0.1.1	1) Update the default scanning frequency in Chart 1 2) Modify physical parameters in Chart 2
2023-05-29	0.1.2	1) Update Chart 1 2) Add section 2.5 Optical Characteristic
2023-07-19	0.1.3	Update Section 1.3
2023-08-09	0.1.4	Update operating temperature
2023-12-07	0.1.5	Update chart 2 weight